

NO	PARÇA KODU	PARÇA ADI	ADET	KUTU
1	ZAST001AYK673607	CILALI AYAK	4	1
2	ZAST001AYK673608	CILALI ORTA AYAK	1	1
3	ZAST001KNS672801	UST TABLA	1	2
4	ZAST001KNS671816	ARKA TABLA	1	2
5	ZAST001KNS673902	CATILMIS ALT TABLA	1	2
6	ZAST001KNS671803	SAG YAN TABLA	1	3
7	ZAST001KNS671804	SOL YAN TABLA	1	3
8	ZAST001KNS671807	ORTA DIKME	1	3
9	ZAST001KNS671808	ARA DIKME	1	3
10	ZAST001KNS671832	CEKMECE MODUL SAG YAN TABLA	1	3
11	ZAST001KNS671833	CEKMECE MODUL SOL YAN TABLA	1	3
12	ZAST001KNS671826	CEKMECE MODUL YAN KAPAMA	2	3
13	ZAST001KNS671861	SAG KAPAK	2	4
14	ZAST001KNS671862	SOL KAPAK	2	4
15	ZAST001KNS672828	CEKMECE KLAPASI	2	5
16	ZAST001KNS671823	CEKMECE SAG YAN TABLA	2	5
17	ZAST001KNS671824	CEKMECE SOL YAN TABLA	2	5
18	ZAST001KNS671825	CEKMECE ARKA TABLA	2	5
19	ZAST001KNS671811	SABIT RAF SAG	1	5
20	ZAST001KNS671812	SABIT RAF SOL	1	5
21	ZAST001KNS671834	CEKMECE TABANI	2	5

KULP	4 ADET
	4 ADET

PLEASE RETAIN THE LABEL INFORMATION ON THE PACKAGES. DO NOT START ASSEMBLY IF THERE ARE ANY MISSING ITEMS IN THE PACKAGE.  
THE MANUFACTURER IS NOT RESPONSIBLE FOR ANY DAMAGES THAT MAY BE INCURRED DURING THE ASSEMBLY PROCESS AND LATER ON DUE TO THE MISUSE OF BUYERS.  
KOLLUZERİNDEKİ ETİKET BİLGİLERİNİ SAKLAYINIZ KOLLUÇERİNİNDE EKŞİK PARÇALARA SAĞLIKLI MONTAJLA BAŞLAYINIZ.  
MONTAJ ESNASINDA VE DAHA SONRA KULLANICI HATLARINDAN DOĞRUKAK HASARLARDAN ÜRETİCİ FİRMA SORUMLU DEĞİLDİR.



444 6 999

Toll-free information line only  
for domestic calls-Türkiye

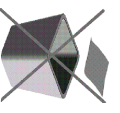
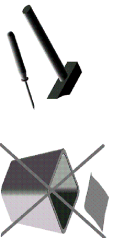

GM-FO-054/REV01

SAYFA NO : 1/4

	KAVELA	METAL ARKALIK L BİRLEŞTİRME	KABİN VIDASI	SUNTA VIDASI	PLESİLİK POLİGRİT	KULP
28 ADET	4x25 YHB SUNTA VIDASI	4 ADET	6x80 GALVANİZLİ GİYATTA	4 ADET	3.5x35 YHB SUNTA VIDASI	4 ADET
4 ADET	DÜZ MENTİŞE	8 ADET	6.3x13.5 GALVANİZLİ GİYATTA	8 ADET	8 ADET	12 ADET
4 ADET	RAFIX	8 ADET	MINİFİX ÇEKİRME (18 mm)	8 ADET	MINİFİX VIDA	4 ADET
8 ADET	RAFIX	39 ADET	MINİFİX PİMLİ TEK AÇILIMLI RAF SOL	39 ADET	MINİFİX PİMLİ TEK AÇILIMLI RAF SOL	2 ADET
4 ADET	RAFIX	39 ADET	MINİFİX PİMLİ TEK AÇILIMLI RAF SOL	39 ADET	MINİFİX PİMLİ TEK AÇILIMLI RAF SOL	2 ADET

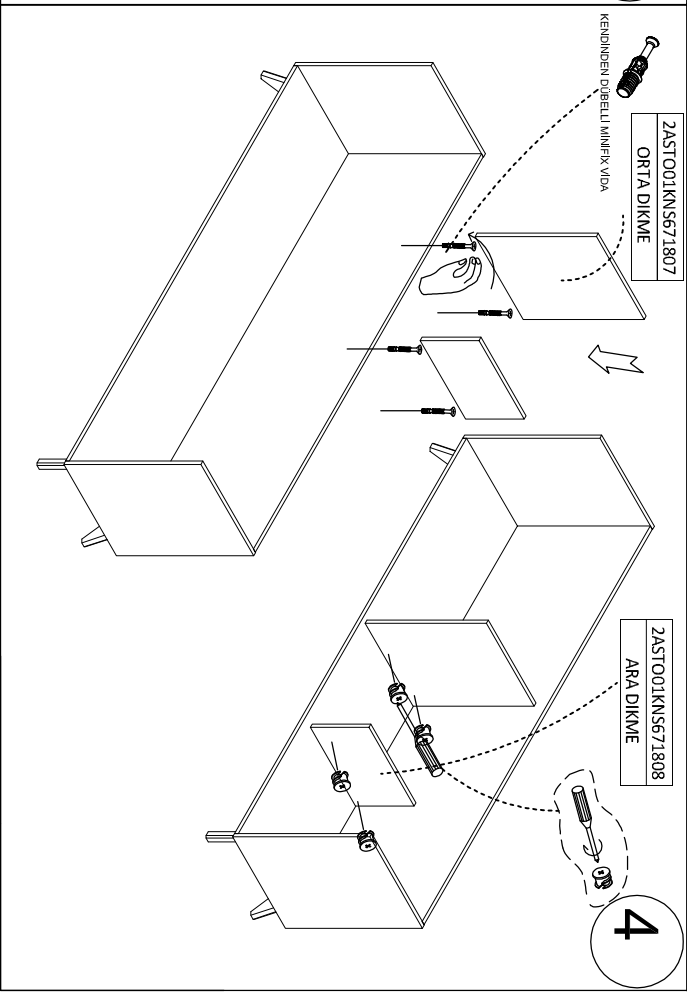
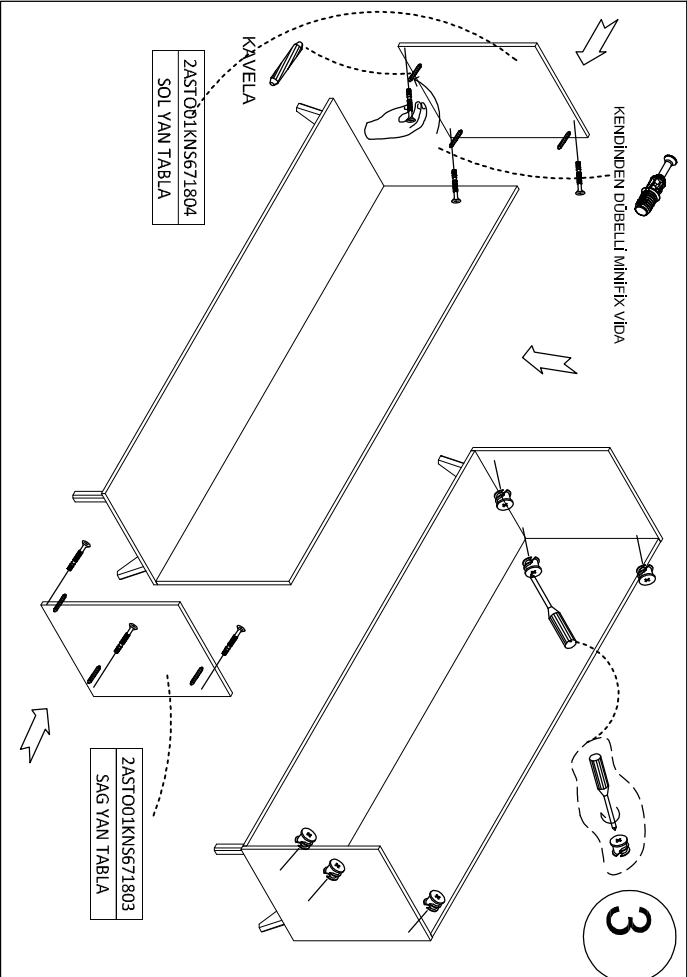
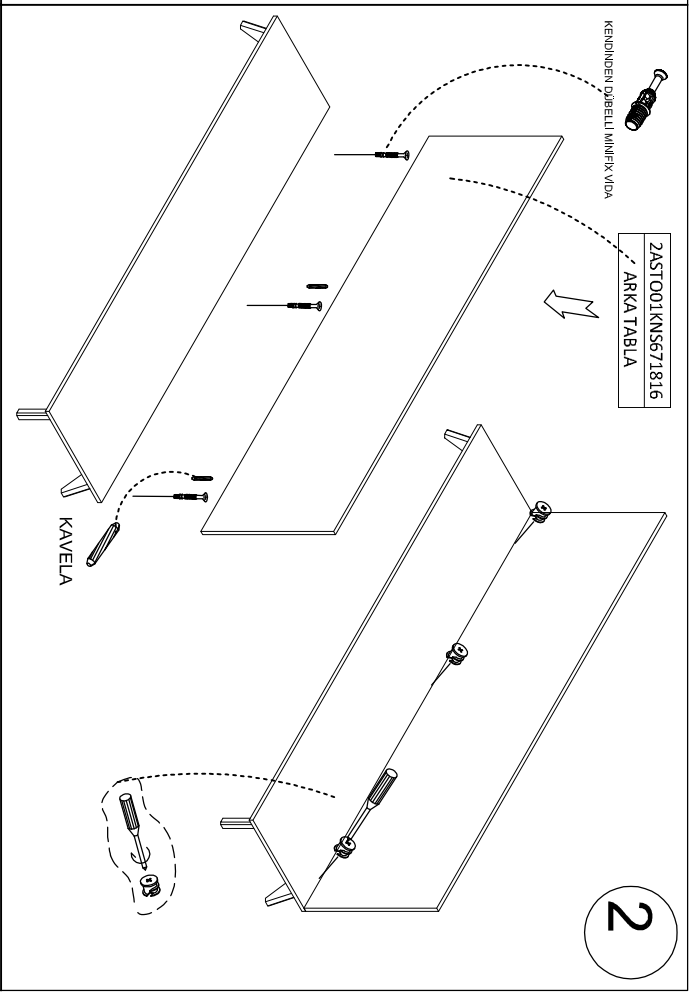
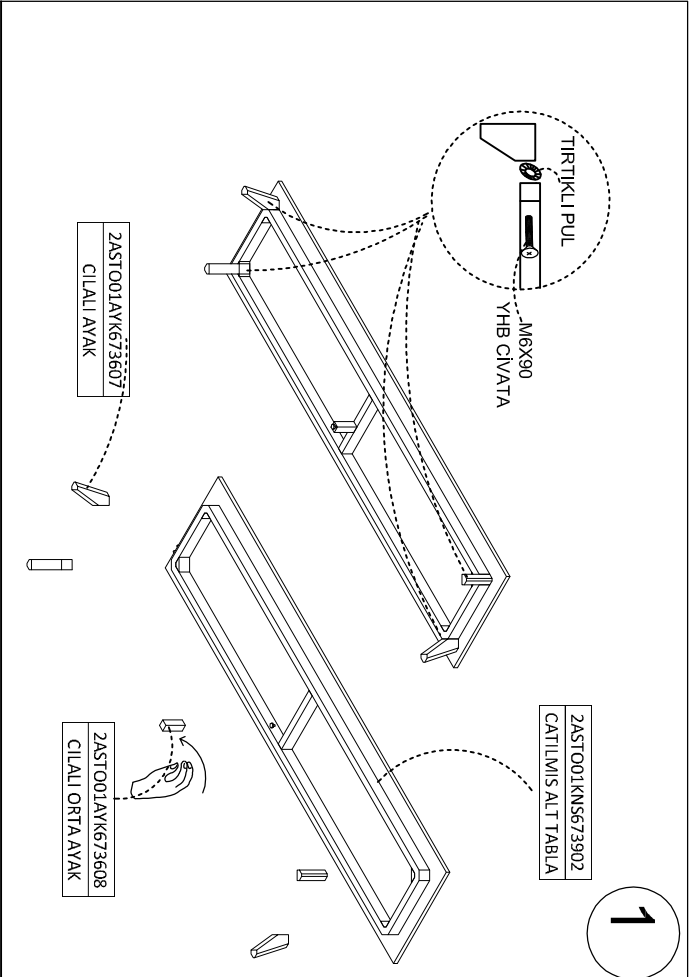

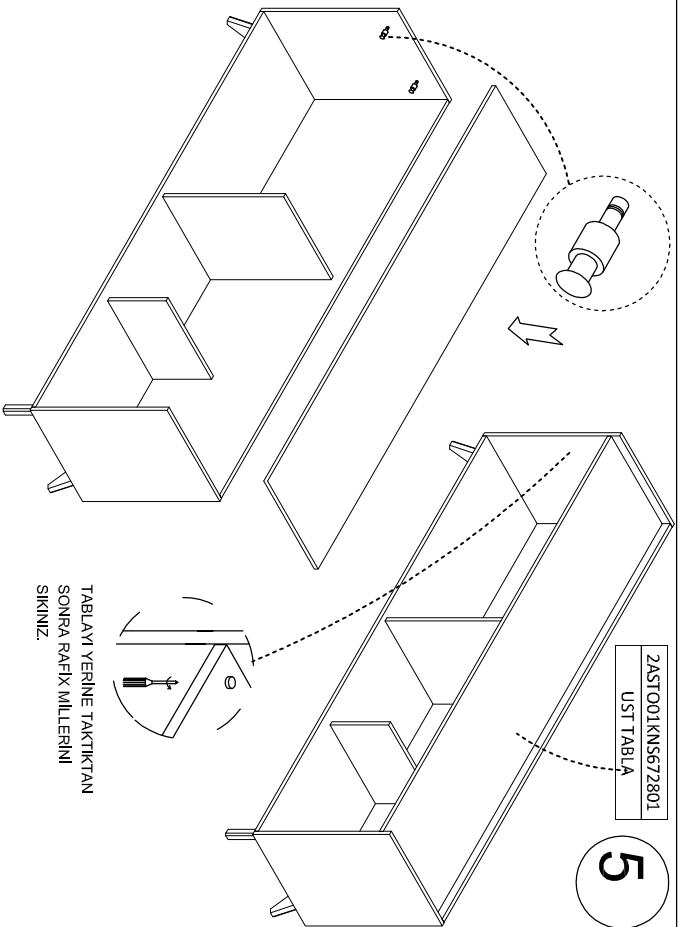

5

MENTEŞE MONTAJI

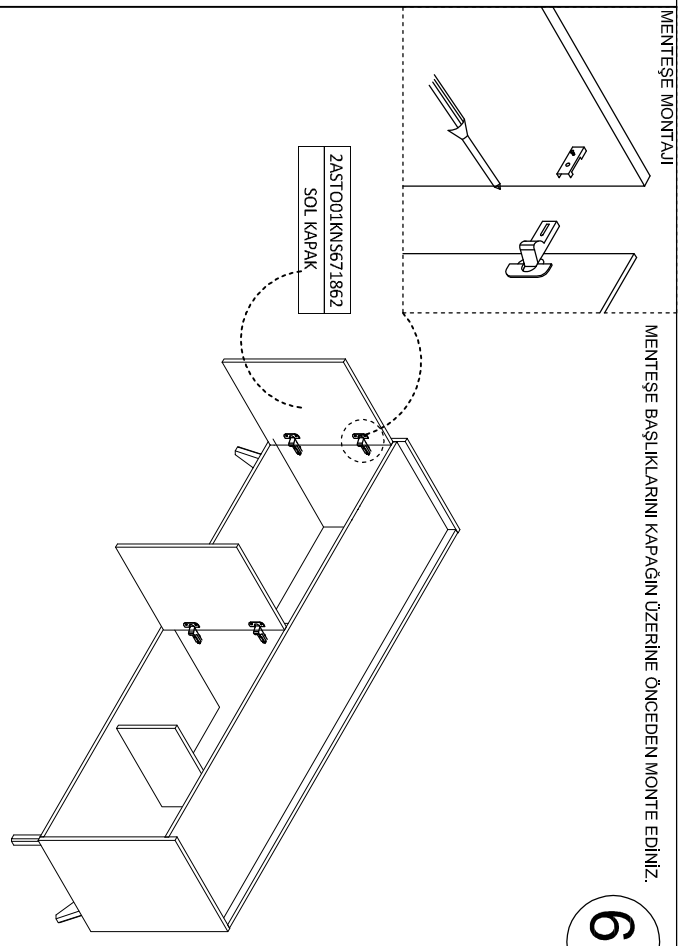

6

7

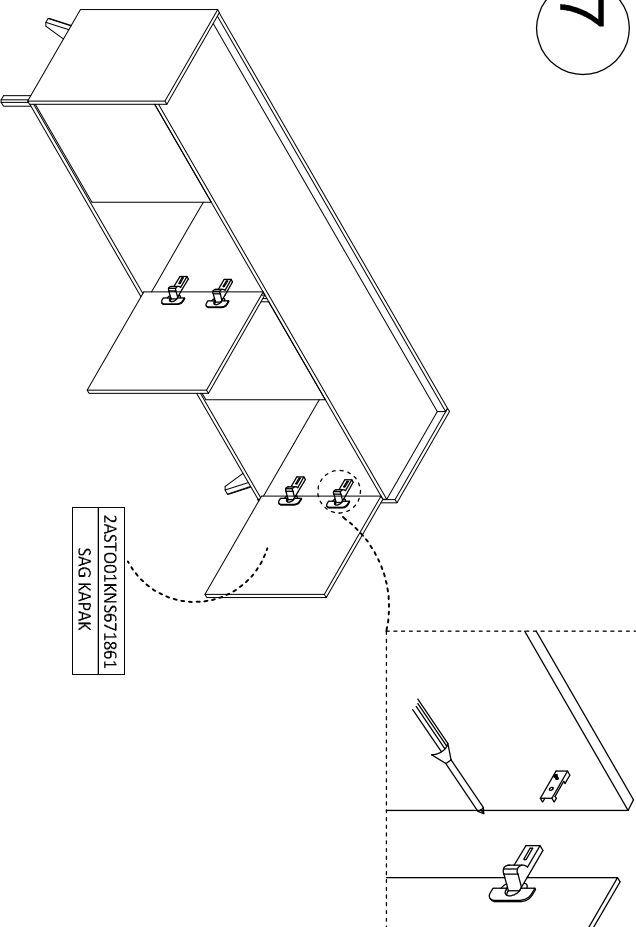

MENTEŞE MONTAJI

8

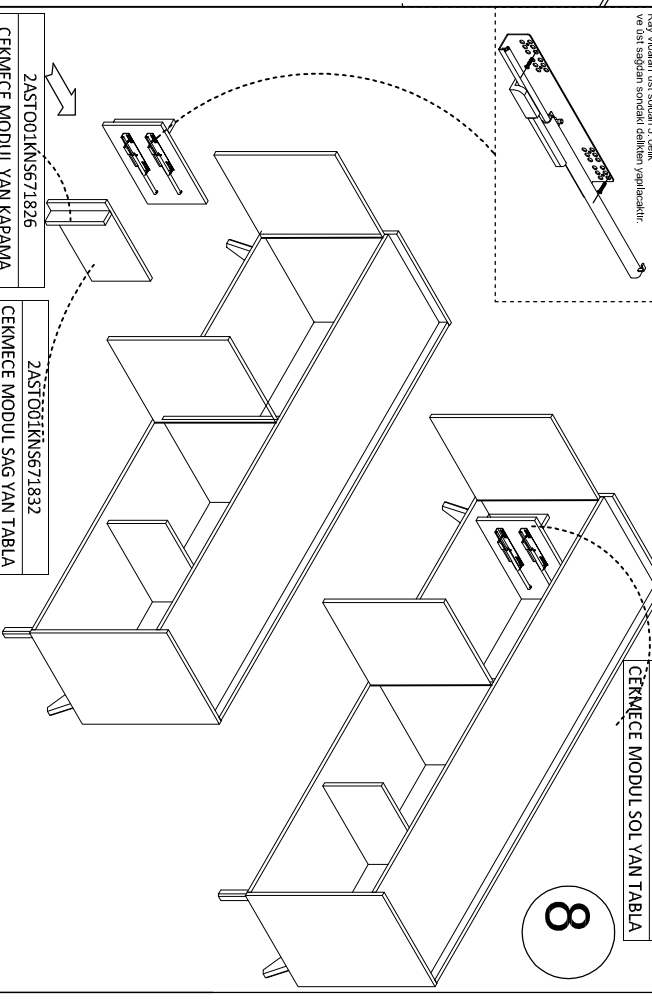

ZAST001KN5671833 ÇEKMECE MODUL SOL YAN TABLA

6,3X13,5 EURO VİDA İLE MONTAJI YAPINIZ.  
Ray vidaları üst selden 3 delik ve üst sağdan sonucaki delikten yapılıncaktır.

